



Welcome to warm water! We appreciate your business and look forward to providing you with years of relaxation and enjoyment. To ensure a seamless delivery of your new hot tub, please use these documents in preparation for the delivery of your new hot tub. Provided below are additional specifications for proper electrical setup.

Electric Installation

There are many ways that a hot tub can be wired **depending** on the exact model and/or brand that you purchase. This means that pre-existing wiring and electrical setups are not sufficient unless it is the exact same setup and model, assuming the manufacturer has not made any changes to the tub.

Your salesperson will provide you with electrical schematics for your new hot tub. Wiring schematics should be given to your electrician to ensure proper wiring of your hot tub.

115V hot tubs have a cord with a GFCI end and 10 ft of usable cord. The 20AMP receptacle box must be installed within 10 ft of the hot tub prior to delivery and the hot tub must be the only appliance powered on that circuit.

220V hardwired hot tubs need a “whip” (a flexible or hard $\frac{3}{4}$ ” conduit containing wires as specified on your tub wiring schematic) from your subpanel to the electrical cutout on the hot tub. You or your electrician **MUST** add additional length in wiring from the opening or where the electrical cutout is shown as an entry point on the hot tub **PLUS** the width and height of the equipment compartment for the final connection to be made. There is an electrical board inside the equipment compartment that the wires are meant to be connected and installed in order to run the hot tub (wires don’t just go into the electrical opening). This ensures that your electrician will have enough slack to connect the wires inside the hot tub. Too long is better than too short (we can wind the excess up in the equipment compartment). If the wires are too short your electrician will have to run an entire new set of wires for the hot tub to run properly and we will not be able to start your hot tub on delivery. Please have your electrician reach out to your local store or salesperson for any clarity needed.

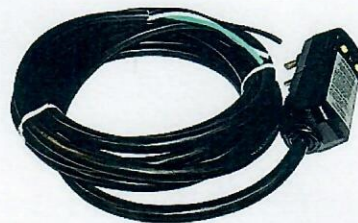

PLEASE NOTE (common error):
The neutral wire in the

subpanel needs to be attached to the breaker, **NOT** on to the grounding bar. The hot tub may not start or the breakers may trip if the neutral wire is not connected properly.

WATKINS MANUFACTURING – “To ensure you will have an opportunity to use your spa soon after delivery, it is very important that the required electrical service has been installed. Unless otherwise stipulated by your dealer, **THIS IS YOUR RESPONSIBILITY.**”

IMPORTANT: All electrical circuits must be installed by a qualified, licensed electrician.”

You can NOT run a hot tub on an extension cord.



Considering converting your Hot Tub from 110V to 220V?

Currently the hot tub models that are able to be converted from 110V to 220V are the Prodigy 2022 and prior, Jetsetter, Beam, Stride, SX, TX, and all FreeFlow hot tubs. Review the Pros and Cons to see if converting the electrical of your hot tub is a good option for you.

Contact your salesperson if you would like to convert to 220V.

110 V, 20A GFCI Cord
115V 15 A GFCI Cord
110V Plug N' Play

Pros

- Ease of installation.

Cons

- Hot tub heater does not operate when jets are in use. Can lose 2-3 degrees per hour depending on the ambient temperature. (110V averages 24hrs to heat depending on size)

Example of 110V- 15A:



220V 50A Subpanel

Pros

- Hot tub heats 4X quicker than 110V (110V averages 24hrs.)
- Jets and heater operate at the same time. No temperature loss while using hot tub.

Cons

- Higher installation cost.
- Requires additional programming on installation of hot tub.

Example of 220V:

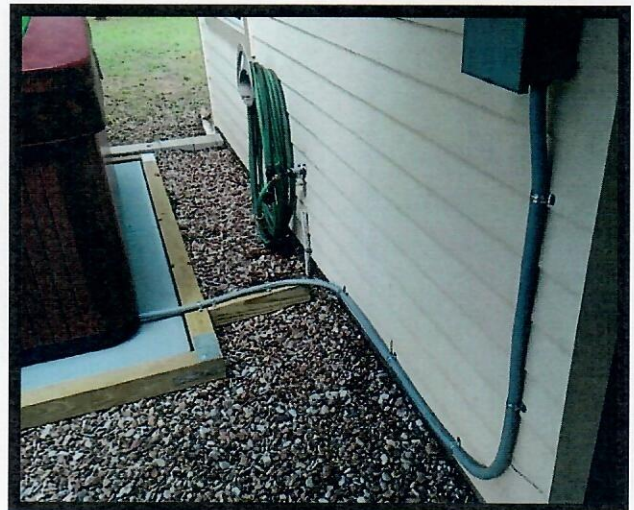

SX

Shell: Pearl
Cabinet: Havana

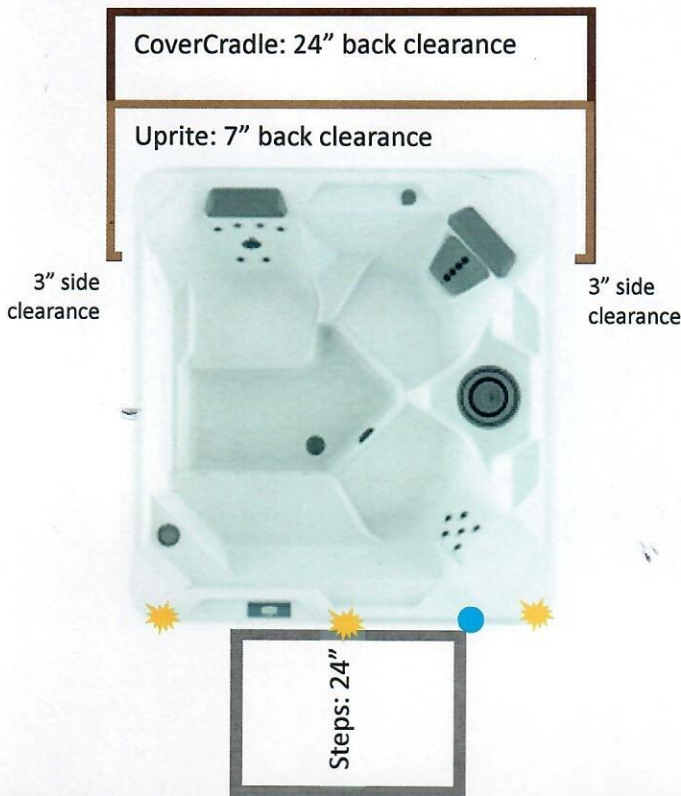

Seating Capacity	3 People
Dimensions	6' x 6'5" x 33" / 1.83 m x 1.96 m x 0.84 m
Water Capacity	230 Gallons / 870 Litres
Weight	645 lbs. / 295 kg dry; 3,090 lbs. / 1,400 kg filled*

18 Jets (all with stainless steel trim)

- 1 Moto-Massage® Jet
- 1 XL Rotary Hydromassage Jet
- 16 Directional Precision® Jets

Water Care System FROG® In-Line Cartridge Ready

Effective Filtration Area 30 sq. ft., top loading (1x PWK30)

Energy Efficiency FiberCor® Insulation; Certified to California Energy Commission (CEC) and APSP 14 energy efficiency standards for portable spas

Jet Pump Wavemaster® 6200; Two-speed:
1.5 HP Continuous Duty
3.2 HP Breakdown Torque

Circulation Pump (optional) SilentFlo 5000®

Heater No-Fault® 1,000 W / 115 V or 4,000 W / 230 V

Control System IQ 2020® 115 V / 15 amp**, 60 Hz (includes G.F.C.I. protected power cord) or 115 V / 30 amp*** or 220 V / 50 amp***, 60 Hz

Cover	3.5" to 2.5" tapered, 1.5 lb. density foam core, with hinge seal
Cover Lifter	CoverCradle®, CoverCradle II®, or Uprite® (F/B only)
Steps	Everwood® - Almond, Havana, Storm Polymer - Ash
Lighting – Interior	6 multi-color LED points of light, dimmable

Shell Colors



Cabinet Colors



Cover Colors

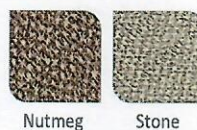

SITE SELECTION AND PREPARATION

IMPORTANT: Site selection and preparation are your responsibility. Carefully read these instructions and consult your authorized Hot Spring® dealer if you have any questions.

You probably have a spot picked out for your new spa, whether it's indoors or outdoors, on a patio or on a deck. Just make sure you check the following:

- Always put your spa on a structurally sound, level surface. A filled spa can weigh a great deal. Make certain that the location you choose can support the weight of your filled spa.
- Locate your spa away from any reflective surface or glass. The heat generated by some types of double-pane windows and reflective surfaces can cause serious damage to the exterior of the spa, including the siding and cover.
- Locate your equipment compartment, which houses all of the electrical components, in a place where water will drain away from it. Allowing water into the equipment compartment can damage the electronics, or may result in tripping your house's circuit breaker.
- Leave yourself easy access to the circuit breaker in the subpanel (when connected to 230 volts), or to the interrupter switch by the end of the power cord (115 volt models).
- Never let water get into the subpanel (when connected to 230 volts), into the interrupter switch (115 volt models), or into the electrical outlet that your spa is plugged into.
- Leave access to the entire front of the spa (the removable panels provide access to the spa's equipment) for periodic spa care and maintenance.

OUTDOOR AND PATIO INSTALLATION

No matter where you install your new spa, it's important that you have a solid foundation to support it. Structural damage to the spa resulting from incorrect installation or placement on an inadequate foundation is not covered under the spa's limited warranty.

DECK INSTALLATION

To be certain your deck can support your spa, you must know the deck's maximum load capacity. **Consult a qualified building contractor or structural engineer before you place the spa on an elevated deck or indoors.** To find the weight of your spa, its contents and occupants, refer to the Spa Specification chart located toward the end of this document. This weight per square foot must not exceed the structure's rated capacity, or serious structural damage could result.

INDOOR INSTALLATION

Be aware of some special requirements if you place your spa indoors. Water will accumulate around the spa, so flooring materials must provide a good grip when wet. Proper drainage is essential to prevent a build-up of water around the spa. When building a new room for the spa, it is recommended that a floor drain be installed. The humidity will naturally increase with the spa installed. Water may get into woodwork and produce dry rot, mildew, or other problems. Check for airborne moisture's effects on exposed wood, paper, etc. in the room. To minimize these effects, it is best to provide plenty of ventilation to the spa area. An architect can help to determine if more ventilation must be installed.

Your Hot Spot dealer can help you with local information such as zoning regulations and building codes.

DELIVERY ACCESS

First, locate the dimensions of your spa on the following chart. The dimensions shown are the measurements of the spa in the vertical position, laid on its side.

Next, contact your dealer to find the height and width added by the delivery cart which the dealer will use to deliver your new spa. Use the height of the cart plus the dimension shown as H to determine the vertical clearance required to pass the spa and cart. Use the width of the cart, or dimension W, whichever is greater, to determine the maximum width of clearance necessary. Use the length dimension L when making any sharp turns to determine the maximum clearance required.

NOTE: It may be necessary to allow for additional overhead clearance if the spa will be rolled up or down an incline or moved up or down a short flight of stairs.

Use the information below to determine the requirements for access to your desired location.

It may be necessary to remove a gate, part of a fence, or other movable obstructions in order to roll the spa to its installation site.

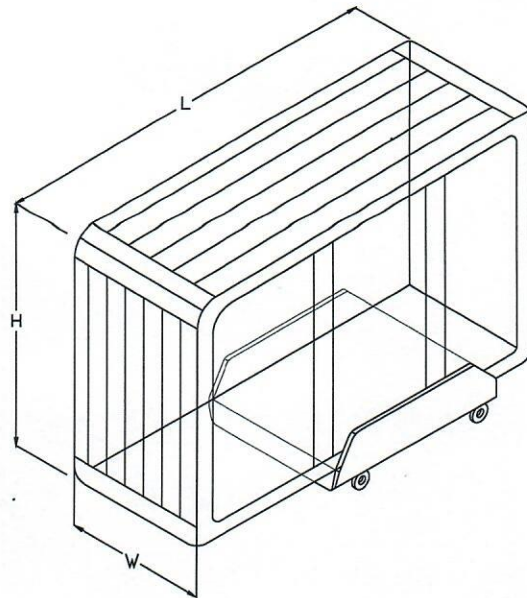

Model	Width W	Length L	Height H
Relay® (REL)	36" (92 cm)	84" (2.13 m)	84" (2.13 m)
Rhythm® (RHY)	36" (92 cm)	84" (2.13 m)	84" (2.13 m)
Pace™ (PAC)	33" (84 cm)	82" (2.08 m)	82" (2.08 m)
Stride® (STD)	29" (74 cm)	84" (2.13 m)	65" (1.65 m)
SX (SX)	33" (84 cm)	77" (1.96 m)	72" (1.83 m)
TX (TX)	29" (74 cm)	72" (1.83 m)	72" (1.83 m)

How is your width clearance?

Check all gates

Protruding electric meters

Gas meters

A/C units

Do you have sufficient overhead clearance?

Check low roof eaves, overhanging branches, rain gutters

Is the path clear?

Move away branches, dog houses, firewood, etc.

If there is a 90° turn, can we clear it? (The spa will not bend)

No more than 6 consecutive stairs without a landing

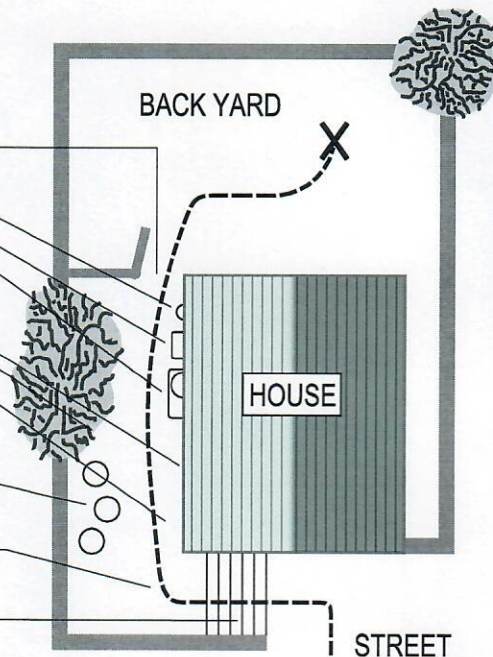

If the spa has to be taken off of the cart to go over a wall (either because the entry area is too narrow, the eaves are too low, the corner is too tight, or the stairway is too steep), a crane will be required. Don't be alarmed! About ten percent of the time, a crane is the only way to install the spa by lifting it to its final destination.

The crane has a truck-mounted boom which can fit right in your driveway. It is run by a licensed and insured operator. For a charge, the crane operator will lift your spa over walls, buildings, or any other obstruction and place it as close to the installation site as possible. The Hot Spring® spa delivery personnel will supervise the crane delivery and complete the spa installation.

NOTE: If your spa delivery requires the use of a crane, you may be required to pay for its services at the completion of the delivery.

GROUND PREPARATION

Your Hot Spring spa has been engineered to perform on all kinds of common yard surfaces. While a concrete slab is best for long-term use*, other foundations are acceptable so long as a level base is prepared prior to delivery.

***NOTE:** Have a reinforced concrete pad at least 4 inches (10cm) thick or a deck that is able to withstand the pounds per square foot listed in the Spa Specification section.

INSTALLATION NOTES:

- Concrete sloped at 1/2 inch per 10 feet (1 cm per 3 m) is preferred so that rain water and water spillover will run off and not puddle underneath the spa (water under the spa for long periods of time may cause the wood to deteriorate).
- If brick or wood decking is selected for the spa foundation, it should be placed and leveled below the entire spa to maintain even distribution of the spa weight.
- It is important to note that if bricks are used to distribute the weight of the spa there may still be a tendency to settle unevenly, resulting in an unlevel spa.
- Remember, placing the spa around grass or dirt may increase the amount of debris which is inadvertently brought into the spa water on the user's feet.

If you are purchasing a deck package or a gazebo with your spa, a solid foundation becomes mandatory. Placing them on any surface other than a single level pad could create problems with their installation. Pictured at right are a few of the recommended surfaces.

As a homeowner, it is your responsibility to provide a suitable, level foundation for your spa. Keep in mind that most delivery crews are not equipped to level and prepare spa sites.

If you are interested in having a concrete slab, brick surface, or wood deck installed, your Hot Spring dealer should be able to suggest a qualified, licensed contractor.

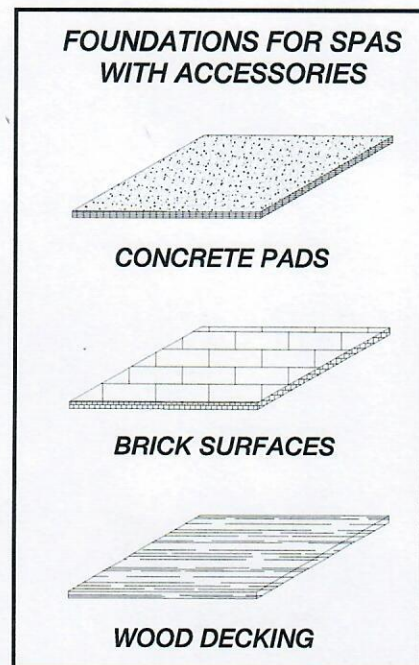

SX (Model SX)

Dimensions

NOTE: All dimensions are approximate; measure your spa before making critical design or pathway decisions. Configuration and location may change without notice.

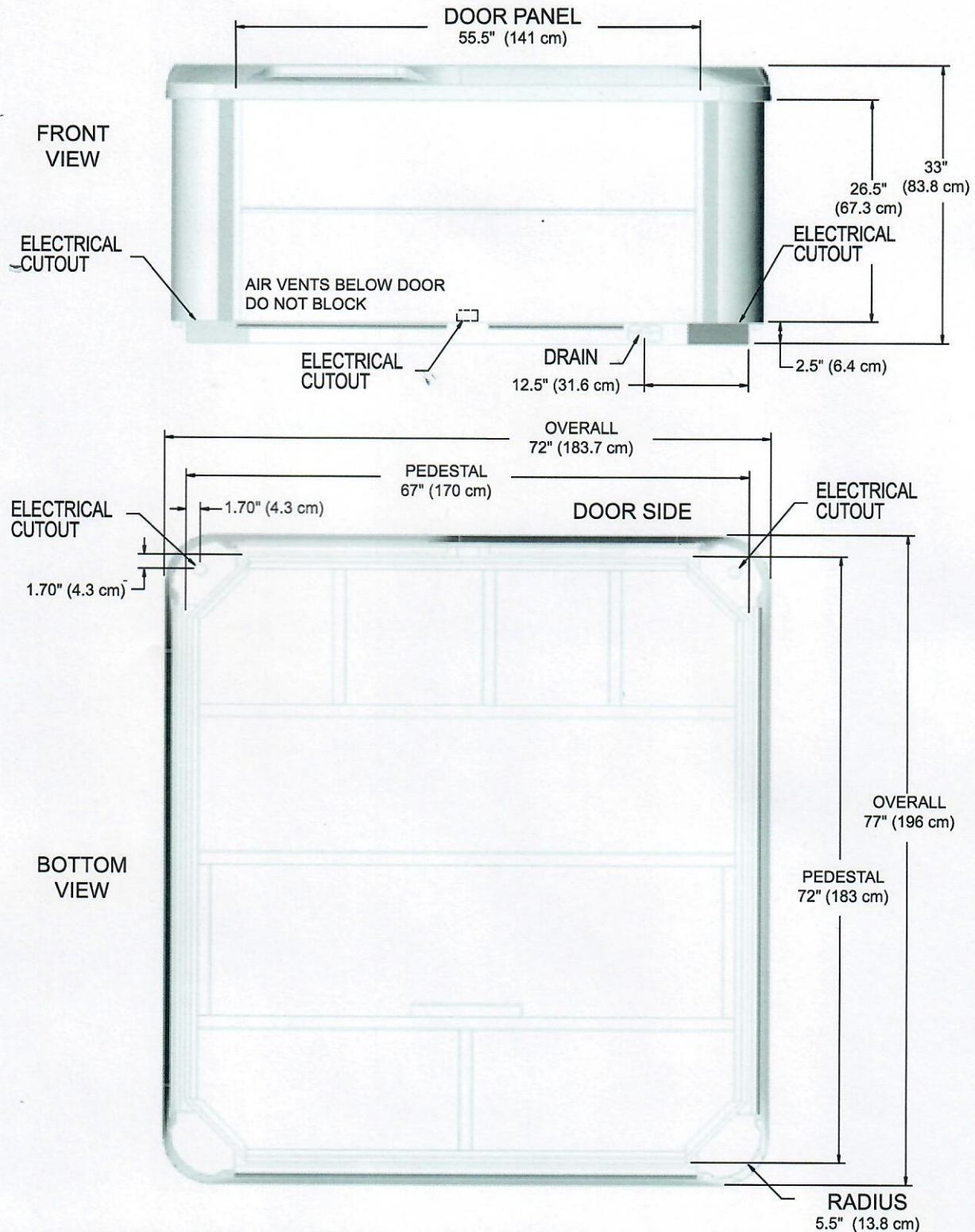

NOTE: WATKINS WELLNESS recommends that the SX be installed on a minimum 4" (10.2 cm) thick reinforced concrete pad or structurally sound deck able to support the "dead weight" found in the spa specification chart.

IMPORTANT: THE SX MUST NOT BE SHIMMED IN ANY MANNER.

ELECTRICAL REQUIREMENTS

SELECTING THE VOLTAGE FOR YOUR SPA

The Pace™, Stride™, SX and TX operates on 115 volts 20 amp (15 amp for TX) 60 Hz. These models can also be converted to either 115 volt 30 amp or 230 volt 50 amp. The Relay® and Rhythm® models require a dedicated 230 volt power supply. When the Pace, Stride, SX or TX is connected to 115 volts 15 or 20 amp, the heater will provide approximately 1000 watts of heat only when the pump is operating in LOW speed and the thermostat is calling for heat. When the Pace, Stride, SX or TX spa is connected to 115 volts 30 amp, the heater will provide approximately 1000 watts of heat when the pump is operating in LOW or HIGH speed and the thermostat is calling for heat. When the Pace, Stride, SX or TX is connected to 230 volts 50 amps, the heater will provide approximately 4000 watts of heat when the pump is operating in LOW or HIGH speed and the thermostat is calling for heat.

All electrical connections must be made in accordance with the wiring information contained in the electrical control box or on the back of the field wiring access panel of the equipment module.

STANDARD, CORD-CONNECTED 115 VOLT 15 OR 20 AMP CONFIGURATION

For your safety, if you are having an electrician install an electric outlet for the spa it should be no closer than 5 feet (1.5 m) and no further than 10 feet (3 m) from the spa. [Reference National Electrical Code 680 - 6a(1) and 680 - 41a.]

One GFCI is used in the cord-connected 20 amp configuration. The GFCI module is located at the end of the power cord. To test the GFCI, simply press the TEST button. The GFCI should trip to the "off" position, disconnecting power to the spa. To reset the GFCI, press the RESET button. The GFCI should reset, and power should be restored to the spa. If the GFCI does not function in this way, unplug the cord and contact an authorized Hot Spring spa service technician.

NOTE: Consult your local code authority to determine if an electrical outlet with a cover is required for your installation. If it is, a suitable outlet cover may be purchased from your authorized Hot Spot dealer.

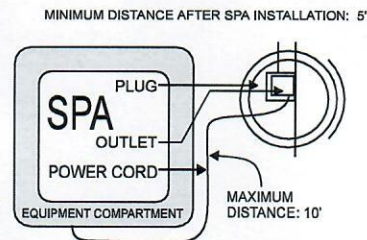

115 VOLT 20 AMP ELECTRICAL REQUIREMENTS

The Pace, Stride and SX spa models must be connected to a 115 volt, 20 amp grounded circuit. A dedicated circuit is required; the term "dedicated" means the electrical circuit is not being used for any other high-load electrical items (patio lights, appliances, garage circuits, etc.). If the spa is connected to a non-dedicated circuit, overloading will result in "nuisance tripping" of the internal fuses or of the breaker switch at the house electrical breaker panel.

The circuit must be properly wired; that is, it must have the following:

- Standard (cord-connected) 115 volt 20 amp (Pace, Stride & SX models) – A minimum 20 amp GFCI circuit breaker in the house panel, #12 AWG or larger wire (including the ground wire) and the correct polarity throughout the circuit.

In addition to the dedicated 20 amp, 115 volt GFCI protected circuit, your spa requires a 20 amp single receptacle. This receptacle, which contains an outdoor-rated, weather-resistant receptacle cover plate, will be provided to you. The single receptacle and cover plate should be installed by your electrician prior to the delivery of your spa.

A pressure wire connector is provided on the exterior surface of the spa's electrical control box, located inside the equipment compartment. This is to permit the connection of a bonding ground wire between this point and any metal equipment, enclosures, pipe or conduit within five feet of the spa (if needed to comply with local building code requirements). The bonding wire must be at least a #8 AWG copper wire.

NEVER CONNECT THE SPA TO AN EXTENSION CORD!

Each Pace, Stride, SX and TX spa comes equipped with approximately 15 feet (4.5 m) of usable power cord (this is the maximum length allowed by regulatory standards and the National Electric Code). The power cord is stored for shipping inside the spa. To remove the power cord, open the equipment compartment and locate the cord. Carefully pull the cord out of the equipment compartment to the desired length and place in center cutout.